



Jøtul F 370 Concept



reddot design award

winner 2007 – best of the best



Unique cast iron design

Welcome to the presentation of our latest range of stoves, the Jøtul F 370 Concept. The stoves have innovative shapes and details with exciting diverse materials. Large side glasses give a fantastic view of the flames, and the top-of-the-range model Jøtul F 373 can be rotated 360° when it is fitted with a flue outlet at the top and the optional turn plate.



red dot design award – best of the best

2,548 international branded products were evaluated in the 'product design class' for the German design award "red dot" in 2007. Jøtul F 373 emerged as one of the winners along with products from Porsche, Prada and Apple ipod. With this award, over 20 of the world's foremost design experts have placed Jøtul on an equal footing with many of the world's most exclusive and well-known brands. "red dot" dates back to 1955 and is awarded annually for outstanding design across several categories. In the past, other Norwegian products have received the 'red dot design award', but the highest commendation 'red dot: best of the best' has never before been given to a Norwegian product.

The Jøtul F 370 concept was launched in June 2006 and has been the biggest sales success of Jøtul's 154 year-long history. The stoves are designed by Anna Øren in Hareide Designmill in Moss, Norway. The Jøtul F 370 Concept has also received the Norwegian Design Council's Award for Design Excellence and the Vesta Award in USA.

Choice of models

The Jøtul F 370 range features three main models with a variety of leg sets. All the models can be made more exclusive by adding elements made of soapstone and glass.

One unique option is that the stoves can be fitted with an additional glass front panel. This lowers the surface temperature also on the front glass. All models come in grey and black paint.

Fairy tale

Unique to this concept are decoration panels for the side windows. You can choose between a classic design "fairy tale" and a contemporary design "reed". The decoration panels can be easily removed and fitted when so desired.



*Jøtul F 373, black paint
with soapstone top*

Jøtul F 371

This version has a leg set in cast iron. The shelf in the base can be removed when so desired. The stove comes in grey and black paint, and an optional top plate in soapstone makes it even more exclusive.



Grey paint



Soapstone top



Glass panles on front, sides and top



*Jøtul F 371, grey paint
with soapstone top*

Jøtul F 372

This stove has a leg set in stone which gives the product a very distinctive look. Jøtul F 372 comes in grey or black paint.



Black paint



Soapstone top



Glass panels on front, sides and top



Jøtul F 372, black paint

Jøtul F 373

This is the top-of-the-range model of the concept, - tall, slim and beautiful. With a flue outlet at the top and the optional turn plate, it can be rotated 360°. This makes the flames visible from every corner of the room.



Black paint



Soapstone top



Glass panels on front, sides and top



Jøtul F 373 is the top-of-the-range model which can be rotated 360° when it is fitted with a flue outlet at the top and the optional turn plate, making the flames visible from every corner of the room.

Technical data

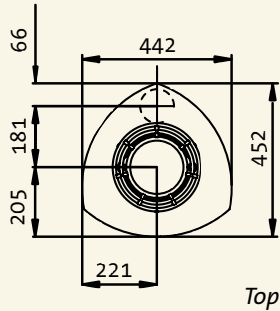

Material: Cast iron
Finish: Black or grey paint
Max log length: 30 cm
Heat output: Minimum 3,5 kW. Nominal 5,5 kW. Maximum 7 kW
Flue outlet: Top, back
Flue size: Ø150 mm/177 cm² in section
Optional extras: Glass panels on front, sides and top (all in one set), top plate in soapstone, decoration panels for side windows, turn plate (360°)

Weight:

Jøtul F 371: 163 kg
 Jøtul F 372: 194 kg
 Jøtul F 373: 156 kg

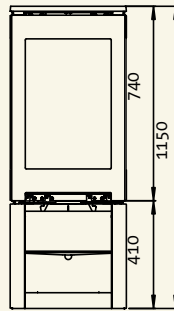

Front

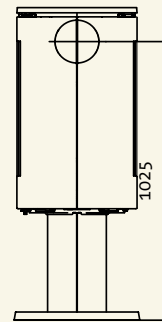

Rear

Distances from flammable materials (mm):

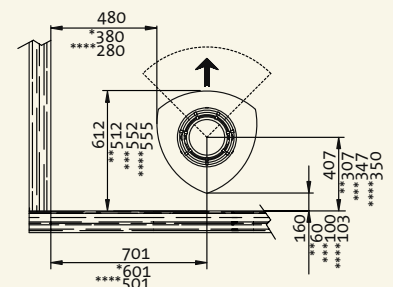
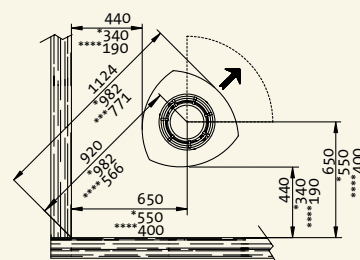
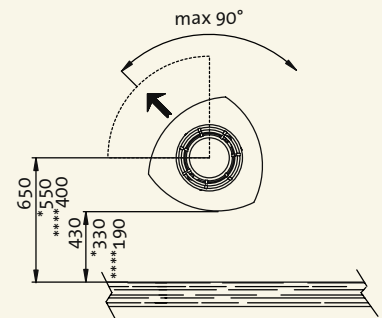
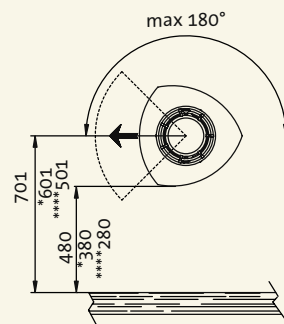

* with covered side windows
 ** with half insulated steel chimney
 *** Jøtul F 372 with outside air
 **** with decor glass



Decor panel "Reed"



Decor panel "Fairy tale"



The Jøtul F 370 concept has innovative shapes and exciting details.



Jøtul AS
P.o. box 1411
1602 Fredrikstad
Norway

E-mail: sales@jotul.no
www.jotul.com

*Jøtul have a policy of constant improvement
and upgrading. Products therefore may differ
in specification, design, material or dimensions
at any time without prior notice.*

June 2007

JØTUL®

Jøtul F 370 Concept